

※NOTES※

MECHANICAL

- ① HOUSING : THERMOPLASTIC-LCP, UL94V-0
- ② SHIELD : COPPER ALLOY
- ③ CONTACT(S) : COPPER ALLOY



SPECIFICATION

- ① CURRENT RATING : 1 AMPHERE
- ② CONTACT RESISTANCE : 100mΩ MAX.
- ③ INSULATION RESISTANCE : 1000MΩ MIN. @ 500V DC
- ④ DIELECTRIC WITHSTANDING VOLTAGE : 500V AC FOR 1 MINUTE
- ⑤ OPERATION TEMPERATURE : -20°C ~ +60°C
- ⑥ STORAGE TEMPERATURE : -40°C ~ +70°C
- ⑦ DURABILITY : 10,000 CYCLES
- ⑧ OPERATION VOLTAGE : 10V AC MAX.

PRODUCT ORDER OPTION

ZCR08 - 11 × R019H3

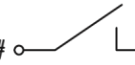
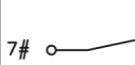
PLATING
 0~Au 0.2~1μ ON CONTACT AREA
 1~Au 3μ ON CONTACT AREA
 4~Au 15μ ON CONTACT AREA

CARD DETECT	7#  8# CARD OUT	7#  8# CARD INSERT
WRITE PROTECT	19#  GND WRITE PROTECTED	19#  GND# WRITE ENABLE

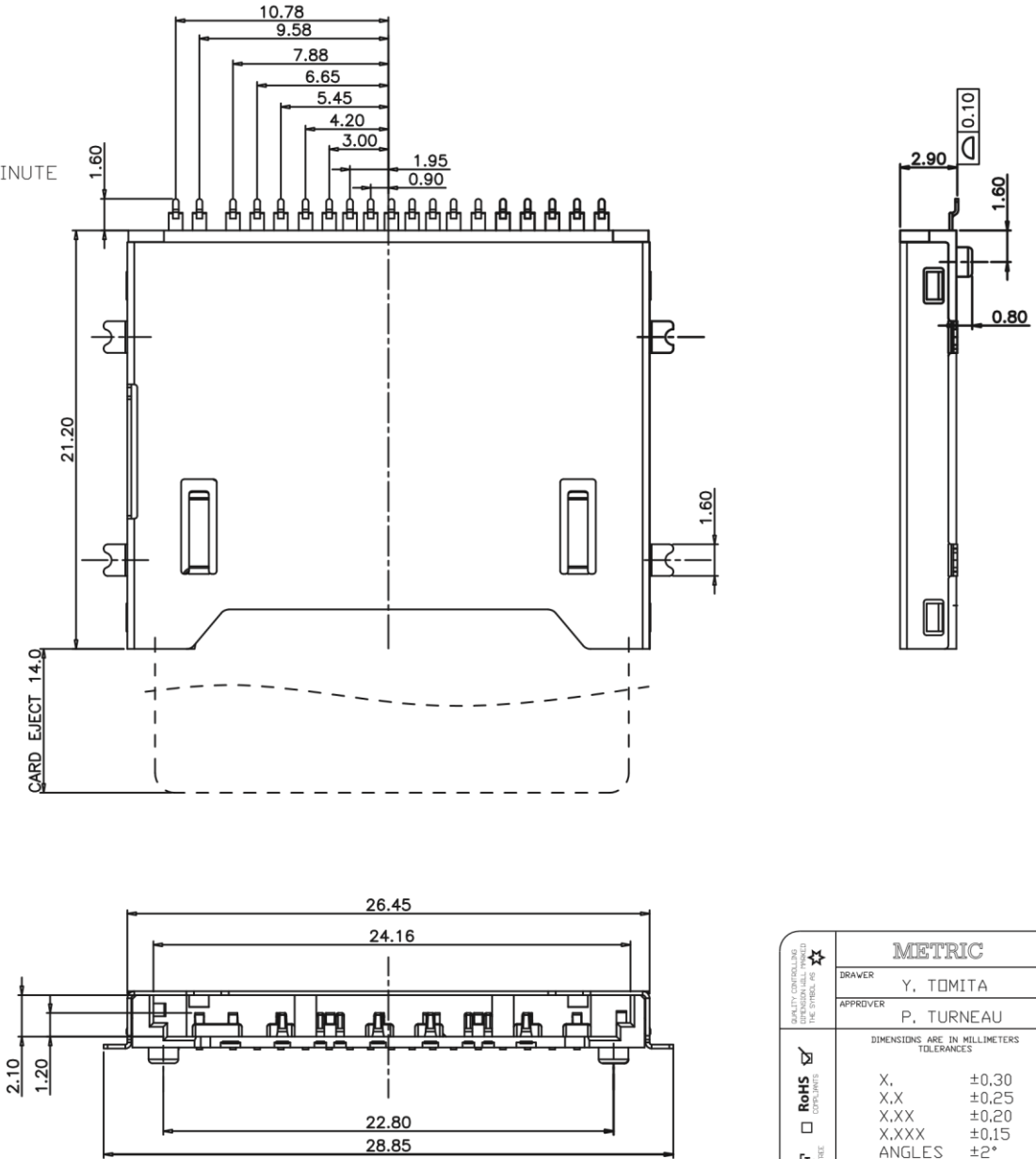

QUALITY CONTROL 品質管理 品質保証 品質保証 品質保証 品質保証	METRIC		Han Electronic
	DRAWER	Y. TOMITA	
	APPROVER	P. TURNEAU	TITLE
	DIMENSIONS ARE IN MILLIMETERS TOLERANCES		SD 4.0 CONNECTOR
	X.	±0.30	
	X.X	±0.25	
	X.XX	±0.20	
	X.XXX	±0.15	
	ANGLES	±2°	
	DO NOT SCALE DRAWINGS		
			PRODUCT NUMBER
	THIRD ANGLE PROJECTION		ZCR08-11×R019H3
	SIZE	REV.	SCALE
	A4		NONE
			SHEET 1 OF 2

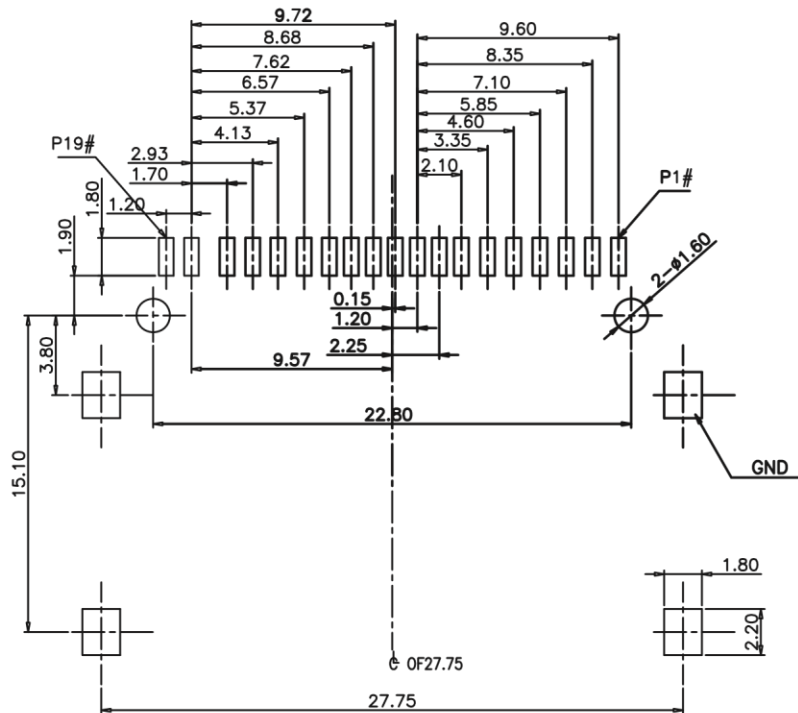
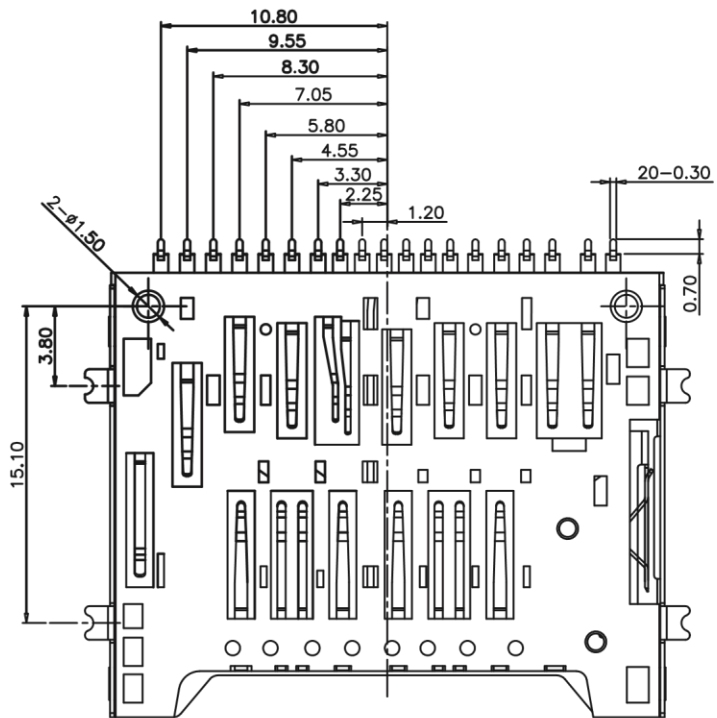

PIN DEFINE:

PIN#	NAME	DESCRIPTION	PIN#	NAME	DESCRIPTION
1	VSS3	GROUND	11	VDD1	SUPPLY VOLTAGE
2	DAT2	DATA LINE BIT2	12	D1-	DIFFERENTIAL DATE 1-
3	DO+	DIFFERENTIAL DATE 0+	13	CLK	CLOCK
4	CD/DAT3	CARD DETECT/DATA LINE BIT3	14	D1+	DIFFERENTIAL DATE 1+
5	DO-	DIFFERENTIAL DATE 0-	15	VSS2	SUPPLY VOLTAGE GROUND
6	CMD	COMMAND/RESPONSE	16	VSS5	GROUND
7	CD	CARD DETECT	17	DAT0	DATA LINE BIT0
8	VSS1	SUPPLY VOLTAGE GROUND	18	DAT1	DATA LINE BIT1
9	VSS4	GROUND	19	WP	WRITE PROTECT
10	VDD2	SUPPLY VOLTAGE(1.8V)			

RECOMMENDER PCB LAYOUT
TOLERANCE UNLESS OTHERWISE IS ± 0.05

METRIC		Han Electronic	
DRAWER	Y. TOMITA	TITLE SD 4.0 CONNECTOR	
APPROVER	P. TURNEAU		
DIMENSIONS ARE IN MILLIMETERS TOLERANCES		PRODUCT NUMBER ZCR08-11×R019H3	
X. ± 0.30 X.X ± 0.25 X.XX ± 0.20 X.XXX ± 0.15 ANGLES $\pm 2^\circ$		DO NOT SCALE DRAWINGS	
THIRD ANGLE PROJECTION		SCALE NONE	
SIZE A4	REV.	SHEET 2 OF 2	